



External Transmission Oil Cooler Kit

Suitable for:



Ford Ranger PX 6 Speed 6R80
Mazda BT50 UR/UP 6 Speed 6R80

WITH THE FOLLOWING ENGINES:

Duratorq P5AT - 3.2L Turbo Diesel - 2011 to 2022
Duratorq ZSD-422 - 2.2L Turbo Diesel - 2011 to 2022

Please read through all of the instructions carefully before proceeding. If any of the information does not appear correct or the diagrams don't match your vehicle, please contact Wholesale Automatic Transmissions on +61 3 9762 8004.

Parts List



2 x Mounted Coolers & Brackets



1 x J-Pipe with Rubber Lined P-Clamp



5m x High Temp Cooler Line Hose with Conduit



2 x Custom Cooler Unions with O-Rings



2 x M6 x 20 SEMS Bolts



4 x Metal Self Tapping Screws



6 x 8-16 Hose Clamps
2 x 14-27 Hose Clamps



1 x Dual Cooler Connection Hose

Expected Installation Time: 3 Hours

Summary of Installation - For Experienced Fitters

- SAFETY FIRST: Allow engine, transmission and fluid to cool prior to starting work to prevent serious injury.
- Remove front grill and bash plates.
- With the coolers facing you, fit the Connector Hose to the right hand union of both coolers. Secure with two (2) supplied 8-16 hose clamps.
- Fit the 5m Cooler Line to the left hand union of each cooler with two (2) supplied 8-16 stainless steel hose clamps.
- Insert coolers from under the car and fit the corresponding top bolt for each cooler by locating mounting bracket behind radiator support panel.
- Check that the coolers and brackets have plenty of clearance and that the bracket is sitting straight, then install the lower two self tapping screws into each bracket.
- Cable tie cooler lines as you work your way to the heat exchanger mounted to the passenger side of the auto, just above the prop shaft. Allow for engine oil filter to be removed for engine maintenance when you are cable tying the lines.
- Accessing through passenger wheel arch, use hose clamp pliers to clamp the 2 x black coolant hoses connected to the heat exchanger.
- Remove four (4) T40 Torx bolts or 10mm hex head bolts to remove heat exchanger. Do not discard bolts or bracket. Fit Custom Cooler unions to transmission and secure with flat bracket & bolt removed from heat exchanger.
- Fit J-Pipe to coolant hoses and clamp with the supplied two (2) 14-27 hose clamps and release hose clamp pliers. Use P-Clamp to secure J-Pipe to a vacant bolt hole.
- Cable tie lines in place and then cut cooler lines to length leaving a little slack for movement. Fit cooler lines using two (2) supplied 8-16 hose clamps.
- Check clearance of hoses and fittings to any other moving/hot part. If needed, top up engine coolant and/or transmission fluid with the recommended fluid
- Test drive vehicle for 15mins and then check all hoses and fittings for leaks and also check mounts and bolts are tight. Clean any oil or coolant residue off vehicle. Road test. Check for leaks. Re-tighten if necessary. Re-check fluid levels.
- Refit any bash plates, grills, aftermarket accessories removed.

Detailed Installation Instructions

Before commencing work, please ensure that you have at least 2L of transmission fluid and enough engine coolant to top up or fill the cooling system at the end of the job.

Please read through all of the instructions as there may be multiple ways to fit the bracket depending on which vehicle variant you have.

1. Remove the front grill of the vehicle and any bash plates that are covering/protecting the transmission and radiator.

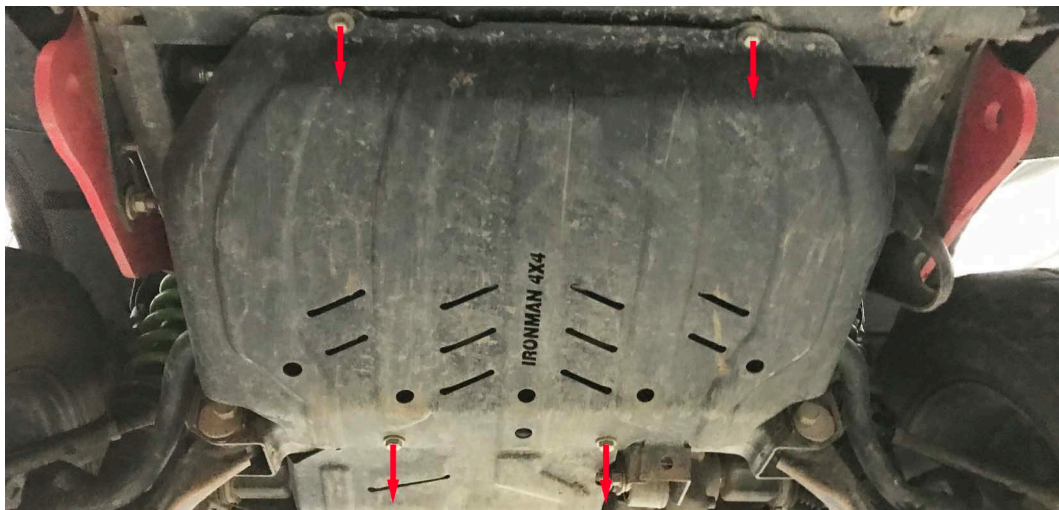

2. Both Coolers and Brackets will come preassembled.

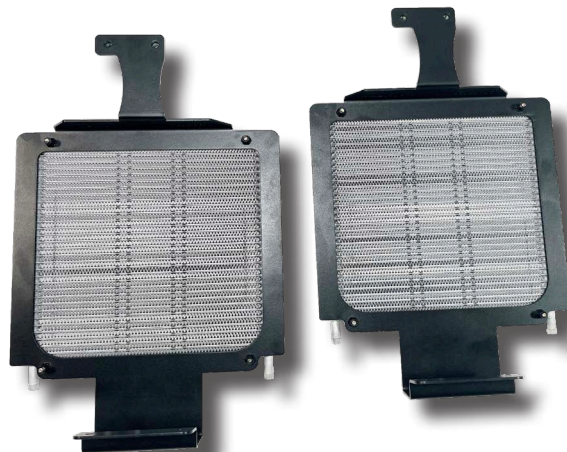

3. Face the brackets with the coolers towards you. Fit the Dual Cooler Connector Hose to the left hand union of each cooler. Secure with two (2) supplied 8-16 hose clamps.

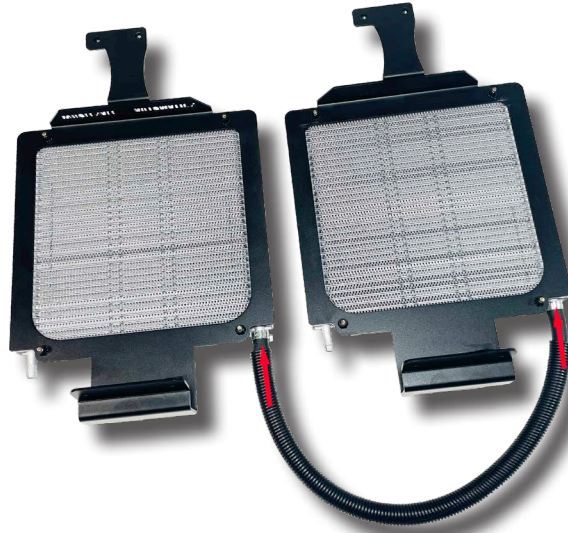

4. Fit the two ends of the 5 meter length of cooler line hose to the remaining cooler unions using 2 x stainless steel hose clamps. Do not cut the looped end of hose yet.



Note: Coolers are bi-directional, so it is not important which cooler is the hot line in and which is the return line out.

5. Both brackets and coolers are identical and interchangeable. In the vehicle, orient the coolers so the brackets are closest to the front of the vehicle. Only 1x M6x20 bolt is used to mount the top of each bracket.



6. These mounting points will align with the holes below on the vehicle.

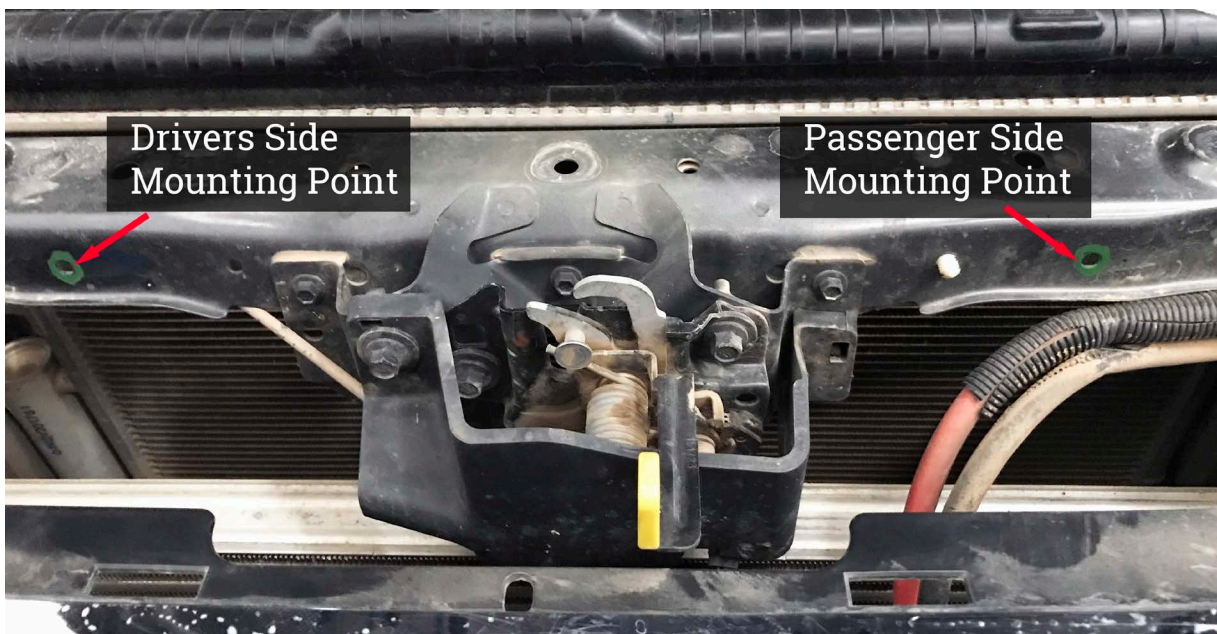

It is recommended the next step is performed by two people, one under the car and the other working from the engine bay.

This step can be completed solo but can be tricky (see step 8).

7. Feed the two coolers up from under the car in front of the air conditioning condenser. Hold the coolers in place and use 1 x M6x20 to secure each bracket to the front cross member. Only finger tighten for now.



8. If completing solo, rest the coolers on the mounts while moving from under the car to above and secure the brackets. Do not tighten yet.



9. From under the vehicle, secure the lower section of the bracket to the under side of the lower support panel using the 4 x Metal Self Tapping screws. Before installing the screws, please make sure the cooler has clearance around it to prevent rubbing against any part of the car.



10. Top mounting bolts can now be tightened.

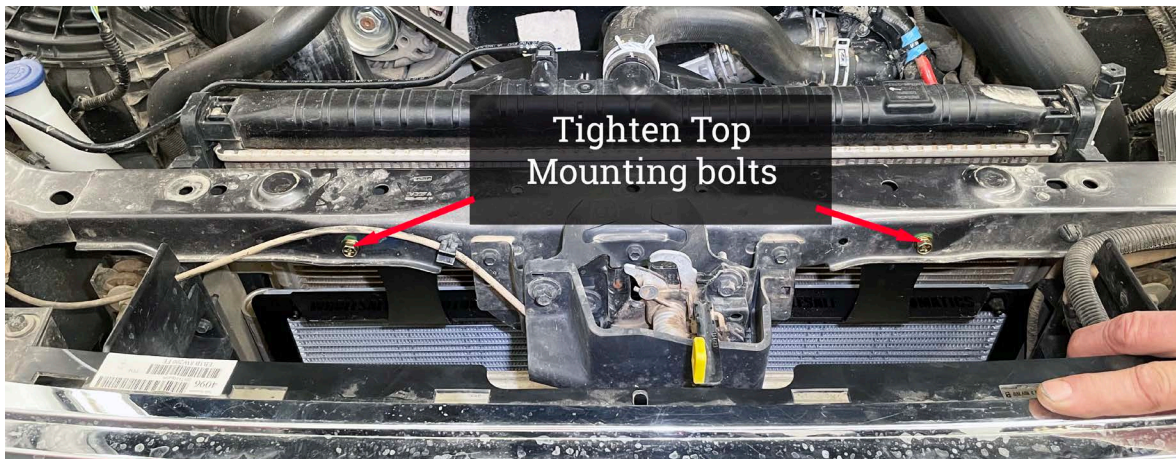

11. Feed the loop end of the lines through the gap directly above the chassis on the passenger side just behind the radiator support panel.



12. Cable tie the cooler lines to the support panel along the way. Some vehicle variants may have an existing factory line running through this location - for those vehicles you will need to route the cooler lines under the radiator.
13. In the passenger side wheel arch, remove the rubber splash protector by removing the plastic screw clips and move protector out of the way.

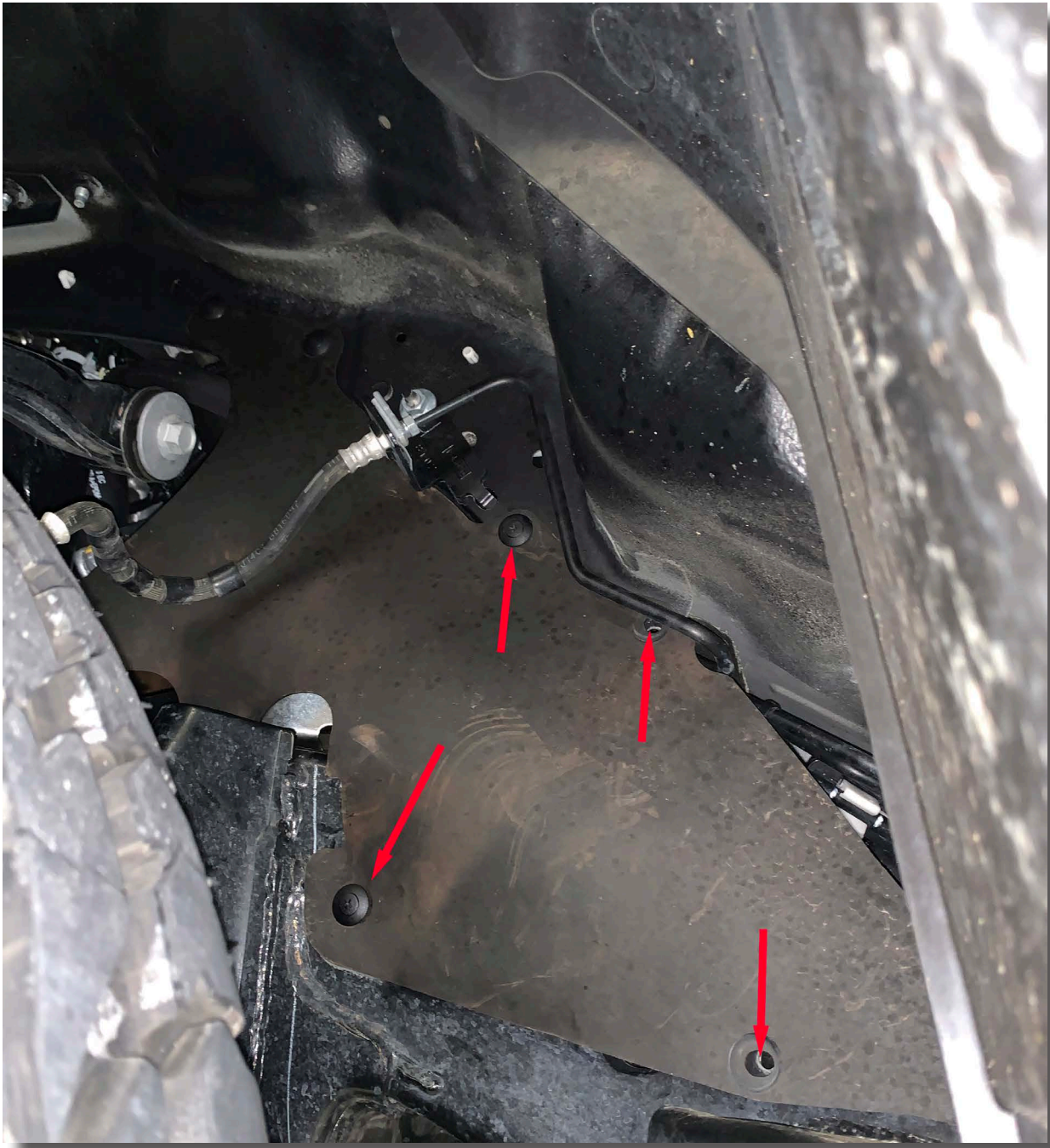

14. Cable tie cooler lines firmly to the vehicle but not too firm that they cause flow restrictions and so that they are not too tight between tie points. Ensure the cooler lines do not prevent access to the engine oil filter by cable tying them to the air con lines above the engine oil filter.

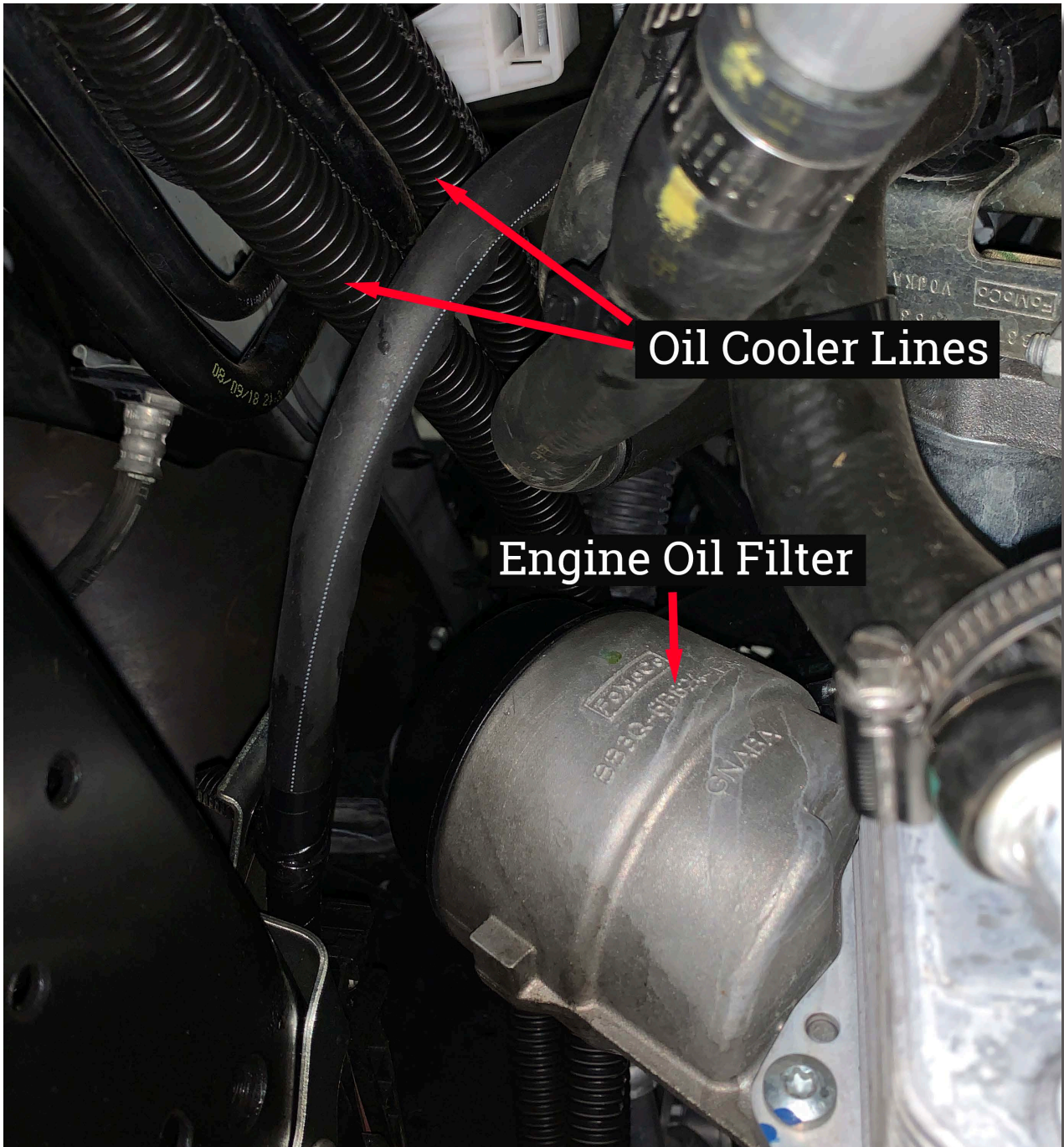

15. The lines need to reach the area on the passenger side of the automatic, just above front prop shaft (Do not cut the hose yet).

16. Using two hose clamps, clamp off the two coolant hoses that connect to the heat exchanger to prevent radiator fluid draining out.



17. Remove coolant hose clamps and then remove the hoses from the heat exchanger. Make sure you have a drain tin or bucket under the hoses to catch the small amount of coolant that will drop out.

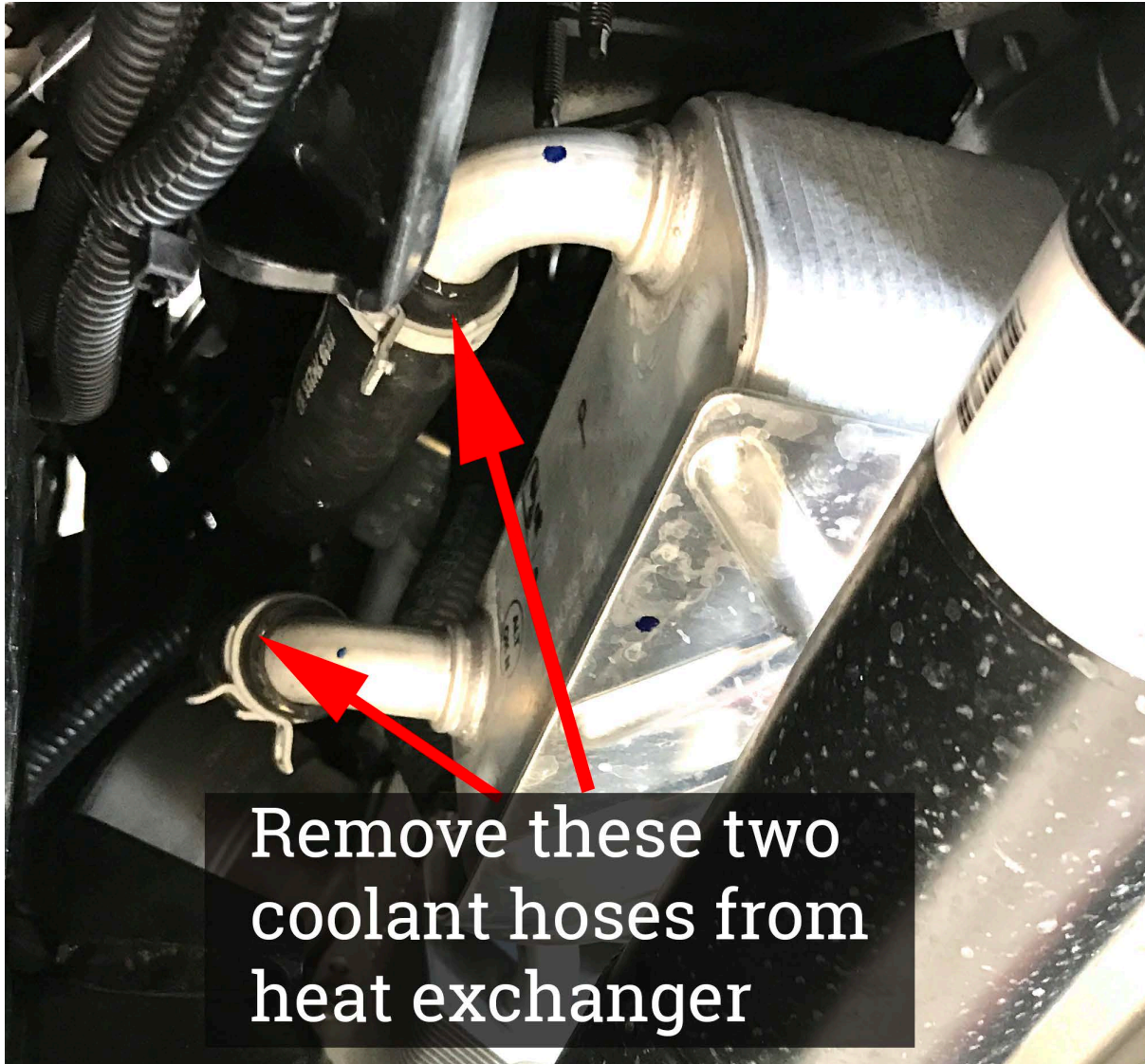

18. Remove the two split pins from the cooler union support bracket and unbolt the Torx bolt (10mm bolt on early models) holding the bracket in place. Remove the support bracket but don't discard as we will reuse this bracket.



19. Unbolt heat exchanger by removing the three bolts holding it to the transmission. Two bolts are above the heat exchanger and one bolt below. All three bolts are either T40 Torx on newer models or 10mm hex head on older models. Do not discard the bolts.

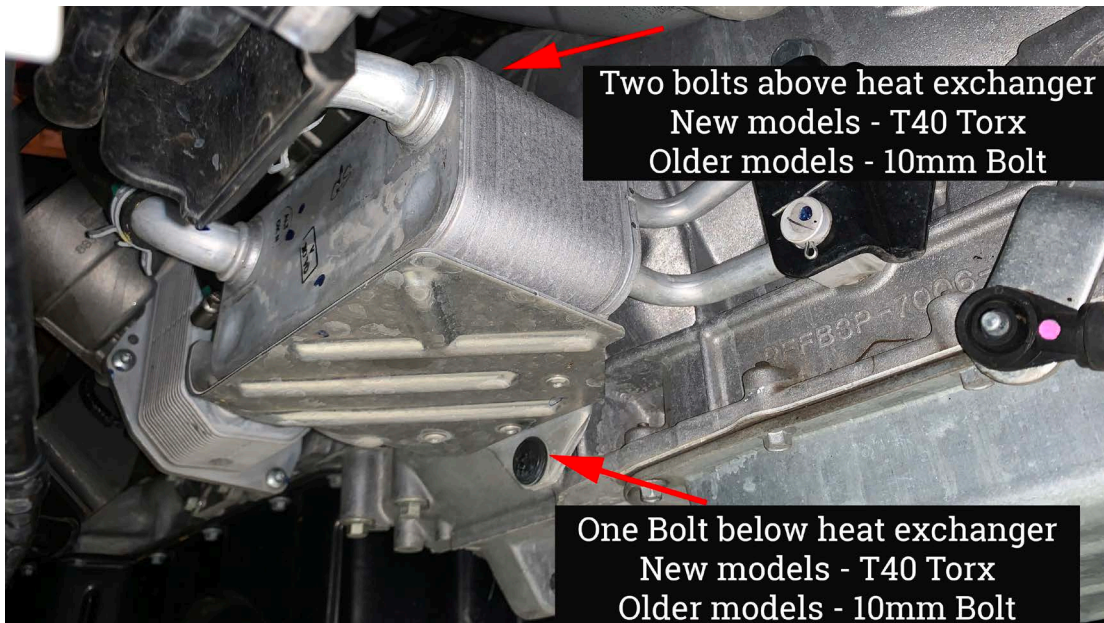

20. Remove the heat exchanger by gently removing the two union lines from the auto first, then the exchanger should be free from the auto. Have a drain tin or bucket underneath as some transmission fluid may come out. On 4WD models it will require a bit of effort to squeeze it down past the driveshaft but it does fit.
21. Check that both custom made unions have two (2) o-rings fitted prior to installing. Run a small covering of transmission fluid around both o-rings on both unions to provide lubrication.

Install the unions by carefully inserting them into the openings left by the heat exchanger. Secure the new unions with the factory support bracket previously removed and secure using one of the T40 Torx bolts (or 10mm hex head bolts).

To prevent oil spilling you can use the rubber covers from the Oil Cooler outlets temporarily until you are ready to fit the lines.

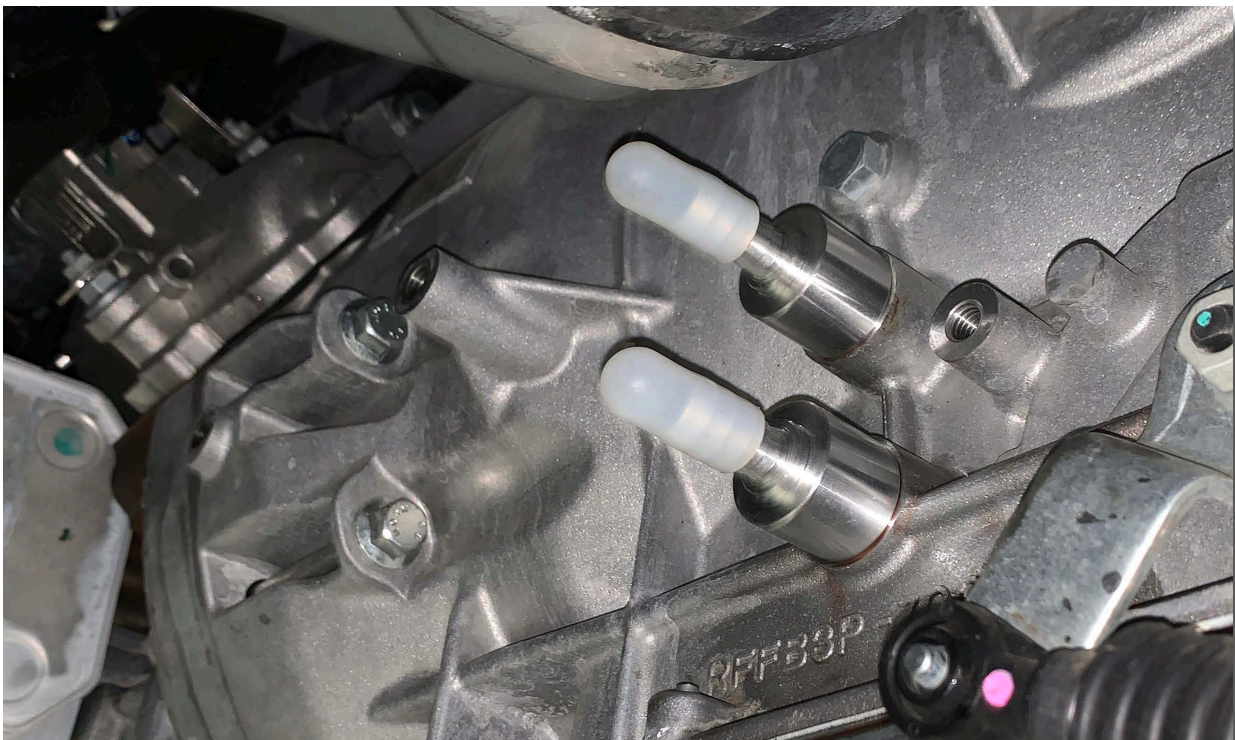

*Note: If installing with a transmission temperature gauge, the union to use for the temperature sensor (Hot Line) is the lower union.

22. Fit J-Pipe to coolant hoses and push in as far as possible. Test that you can easily maneuver the J-Pipe near one of the heat exchanger vacant bolt holes for securing the J-Pipe after fitment. Clamp the coolant hoses using the two (2) supplied large hose clamps.
23. Secure the J-Pipe to one of the heat exchanger vacant bolt holes using the previously removed T40 torx bolt (10mm hex head bolt).



24. Check the routing of the cooler lines prior to cutting to ensure they will not impact on any part of the vehicle or could become jammed or pinched. Cable tie them so they keep sufficient clearance around the engine oil filter for ease of engine maintenance.

25. Measure where they need to be cut for the unions while allowing for some slack between the unions and the first cable tie point.
26. Cut rubber cooler lines to length and pull back the conduit. Slide the remaining small hose clamps onto the cooler hose and then insert the hoses onto the unions. Do not use any lubricant on the barbed fittings. Re-fit conduit into place, trim if necessary.

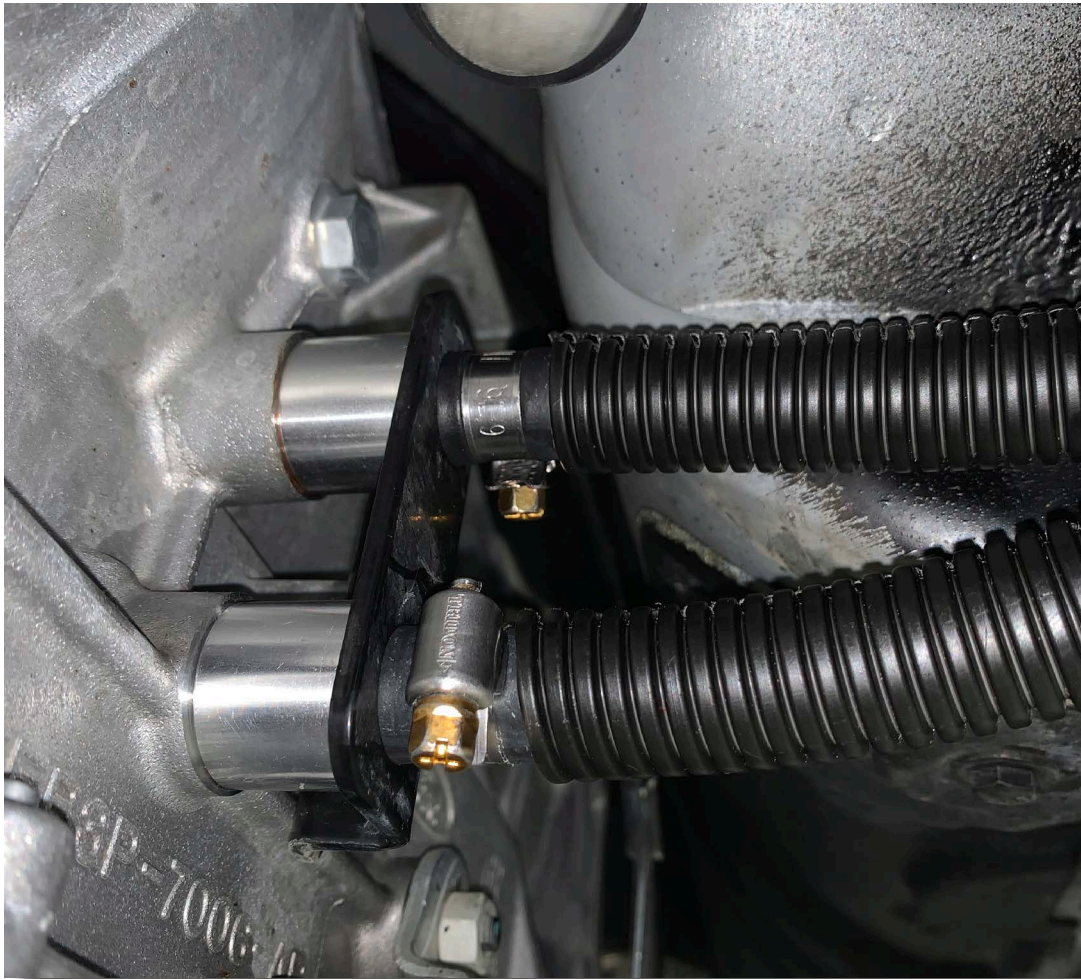

27. Check clearance of hoses to front prop shaft. Cable tie the coolant hoses to prevent rubbing.

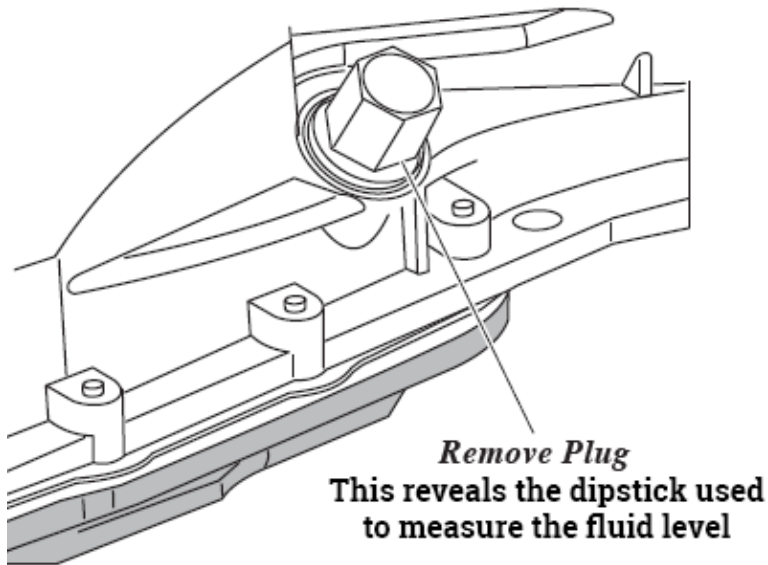
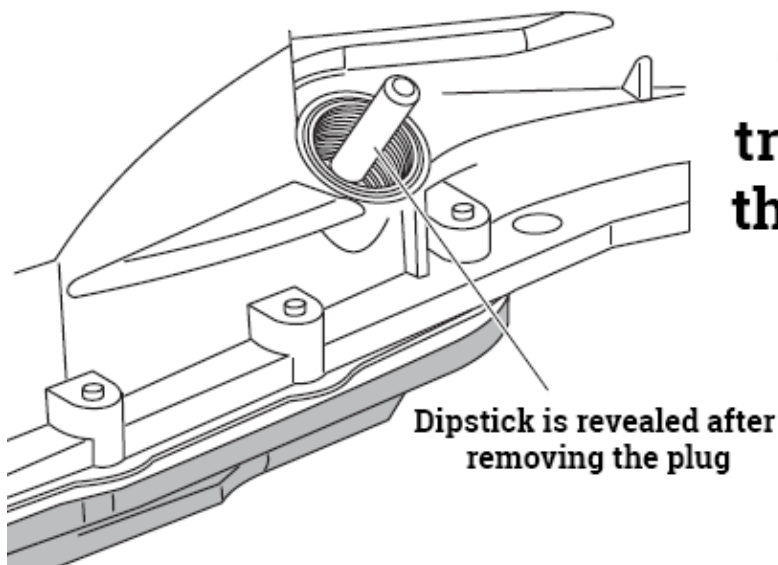

28. Recheck transmission coolers, fittings, hoses, unions, mountings and clamps for any leaking or loose fittings. Tighten if necessary.
29. Check the transmission fluid level and if necessary, top up with Genuine Transmission Fluid or any full synthetic transmission fluid that meets or exceeds the genuine oil specification.
30. Check engine coolant level and top up with the manufacturers recommended coolant.
31. Clean any spilled engine coolant or transmission fluid from under the vehicle so that it is easy to detect a leak. You can use brake cleaner as it will evaporate quickly. Avoid spraying exhaust and body work with brake cleaner or solvent.
32. Road test vehicle for a minimum of 15 minutes. Try to find a couple of hills that will get the transmission to work hard.
33. Check the transmission coolers, fittings, hoses, unions, mountings and clamps for any leaking or loose fittings. Tighten if necessary.
34. Check engine coolant level and transmission fluid level again.
35. If step 34 required tightening of any part or if Step 34 resulted in coolant or transmission fluid showing low, repeat steps 28 to 34.
36. Refit any bash plates, front grills or aftermarket accessories that were removed during the fitment of the cooler kit.

FLUID FILL PLUG***FLUID LEVEL INDICATOR***

The recommended transmission fluid for the Ford 6R80 6 Speed is Mercon LV[©]

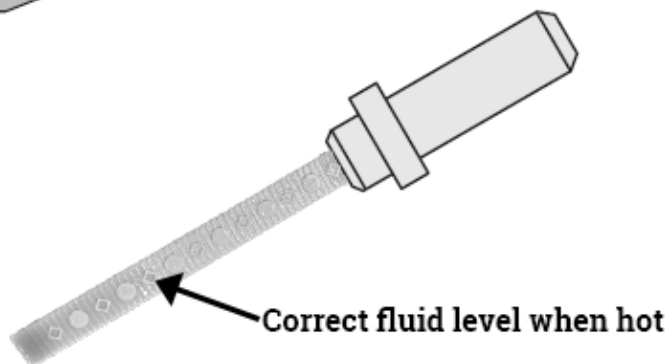

Check fluid level hot idle in park

This completes the installation of the Dual External Transmission Oil Cooler Kit: Ford Ranger PX 6 Speed Mazda BT50 UP/UR 6 Speed

Please remember ALL automatic transmissions have a service interval of 2 years or 40,000km to improve the longevity of the transmission.

Please Provide us with Feedback

If you have a minute to provide us with some feedback about your experience with Wholesale Automatic Transmissions and our products, that would be greatly appreciated.

Using your smart phone or device's camera app, point at the QR code below to take you straight to our feedback page for you to choose the most appropriate feedback method.

